

# FASTPETTE<sup>PRO</sup>

CE



**Labnet**   
**Labnet International, Inc.**

31 Mayfield Avenue, Edison - NJ 08837 - USA  
Phone: +1-732-417-0700  
email: [Labnetinfo@corning.com](mailto:Labnetinfo@corning.com)  
[www.labnetinternational.com](http://www.labnetinternational.com)

# FASTPETTE PRO

1

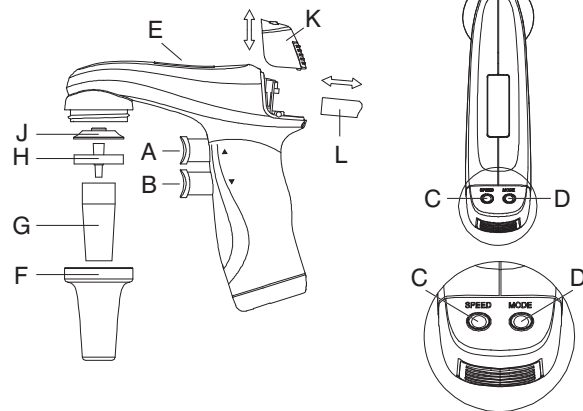

2

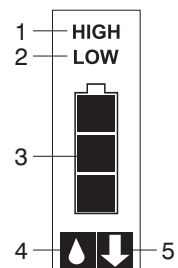

- A - Aspiration button - PP
- B - Dispense button - PP
- C - Speed switch - PP
- D - Mode switch - PP
- E - Display
- F - Nosepiece - PP
- G - Pipette holder - SI
- H - Membrane filter - PP / PTFE
- J - Connector gasket - SI
- K - Batteries cover - PP
- L - Battery - NiMH
- M - Charging stand - PP
- N - Charger 9V: EU, US, UK, AU  
INPUT: 100-240V, 50/60Hz, 0.3A  
OUTPUT: AC DC 9V, 230mA

Casing - PP

3

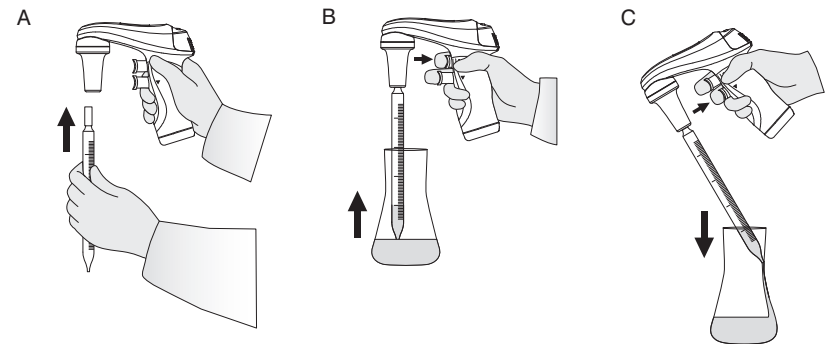

4

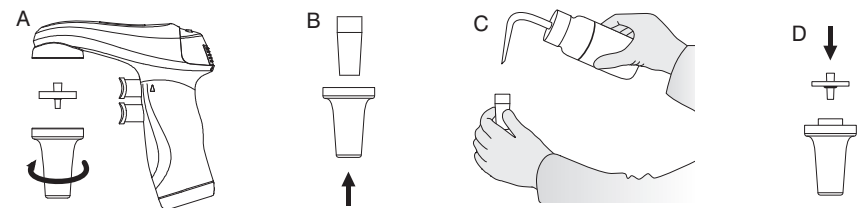

5

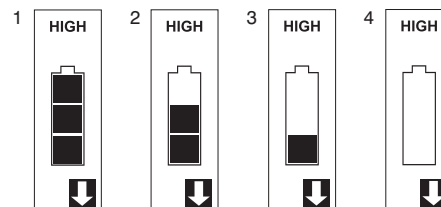

6

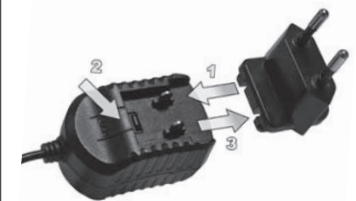

7

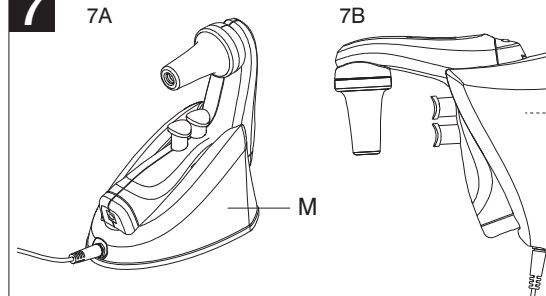

8

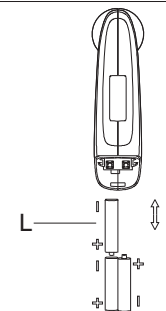

## TABLE OF CONTENTS

1 - INTRODUCTION .....	2
2 - WORK SAFETY INSTRUCTIONS .....	2
3 - LIMITATIONS OF USE .....	3
4 - TO SWITCH ON THE <b>FASTPETTE PRO</b> .....	3
5 - ASPIRATING AND DISPENSING LIQUIDS .....	3
6 - TROUBLESHOOTING .....	4
7 - REPLACING THE FILTER .....	6
8 - CHARGING THE BATTERIES .....	6
9 - MAINTENANCE .....	7
10 - COMPONENTS .....	7
11 - ORDERING INFORMATION .....	8
12 - SPARE PARTS .....	8
13 - PRODUCT DISPOSAL .....	8

## 1 - INTRODUCTION

The **FASTPETTE PRO** pipette controller is a device intended for pipetting liquids with the use of measuring pipettes. It can work with all types of glass or plastic pipettes in the volume range from 0.5 ml to 100 ml.

Two dispense modes permit selection of dispensing intensity depending on the user's needs. The selected setting of the pipette controller mode is shown on the display (fig. 1E)

Fig. 1 shows the external parts of the pipette controller with a description of the materials used.

Display indicators are shown in fig. 2.

## 2 - WORK SAFETY INSTRUCTIONS

 **WARNING! Risk of injury**

**CAUTION: Risk of damage to the device or errors in pipetting of liquids**

Before starting the work with the **FASTPETTE PRO** every user should read these operating instructions carefully.

**CAUTION:**

- Using the device inconsistently with the operating instructions may result in damaging the device.
- The device should be maintained only at an authorised service centre, otherwise the manufacturer will be relieved from any liability under the warranty.
- Only original spare parts and accessories, recommended by the manufacturer, shall be used.
- Only the original charger, supplied by the manufacturer, shall be used for charging the batteries.
- In case of incorrect functioning of the pipette controller, work shall be stopped. The device shall be cleaned in accordance with the operating instructions and/or sent for repair to an authorised service centre.
- In the case of mechanical damage to the casing, the device shall be immediately sent for repair to an authorised service centre.
- The use of excessive force during work shall be avoided.

 **WARNING!**

- During the work with the **FASTPETTE PRO** general safety regulations regarding risks related with laboratory work should be observed. Protective clothing, goggles and gloves should be worn.
- The **FASTPETTE PRO** shall be used only for measuring liquids in conditions specified by the manufacturer, which are limited due to the chemical and mechanical resistance of the device, as well as the user safety.
- The pipette controller should not be used in an environment where explosion risk is present.
- The information and instructions provided by the manufacturers of the reagents must be observed.

## 3 - LIMITATIONS OF USE

- The **FASTPETTE PRO** may not be used for measuring substances, the vapours of which damage the following plastics: PP, SI, EPDM, POM.
- The pipette controller may not be used in an environment where explosion risk is present.
- Flammable liquids shall not be measured - in particular substances with flash-point below 0 °C (ether, acetone).
- The pipette controller shall not be used for drawing acids with a concentration above 1 mol.
- The pipette controller shall not be used for drawing solutions with a temperature above 50 °C.
- The pipette controller may work in temperature range from +10 °C to +35 °C.

## 4 - TO SWITCH ON THE FASTPETTE PRO

Take off the batteries cover and place the batteries according to the drawing (fig. 8). Place the batteries cover, wait a moment till the icons appear on the display. Before the pipette controller is activated for the first time the batteries should be charged. Batteries full charging state is indicated by successive lighting „bars” in the display according to the section 8 in the instruction manual.

The **FASTPETTE PRO** pipette controller is switched on by pressing any of the buttons. The display will show the selected aspiration mode, dispense mode and the batteries level indicator. Examples of the display indications are shown in (fig. 5.1). The batteries are discharged and requires charging if the indicator does not display "bars" (fig. 5.4). When the batteries are fully charged, the indicator displays three „bars” (fig. 5.1).

The **FASTPETTE PRO** switches off automatically if not used for 5 minutes.

The **FASTPETTE PRO** may be charged only with the original charger.

The mains voltage shall conform with the specification on the charger.

Charging shall be done in accordance with section 8 of the instruction manual.

## 5 - ASPIRATING AND DISPENSING LIQUIDS

### Attaching a pipette

**CAUTION:** Before attaching a pipette check whether the pipette is not damaged, has no dents or sharp edges in the gripping part. Check whether the gripping part is dry.

The pipette shall be gripped as close to the upper end as possible and carefully inserted into the pipette holder until resistance is noticed (fig. 3A).

### WARNING!

Do not apply excessive force so as not to damage thin pipettes and to avoid injury risk. A pipette that has been correctly attached and sealed in the holder should not tilt to the sides.

After attaching a pipette hold the device in such a way as to keep the pipettor in vertical position. After finished work it is recommended not to leave the device with attached pipette for a longer period, for example overnight or over a weekend.

**CAUTION:** Do not put aside the pipette controller if there is liquid in the pipette.

### Filling the pipette

Before aspirating is started, set the speed by successive pressing the SPEED switch (fig. 1C) until the display shows the right speed (fig. 1E).

- HIGH speed - fast aspirating (fig. 2.1)
- LOW speed - slow aspirating (fig. 2.2)

It is recommended to choose the LOW position for pipettes with a volume up to 5 ml, and the HIGH position for pipettes with a volume greater than 5 ml. Holding the pipette controller in such a way that the pipette is in vertical position immerse the pipette end in the liquid to be drawn up (fig. 3B), and press the aspiration button gently. The pipette filling speed depends on how deep the aspirating button has been pressed. The deeper the button is pressed the faster the liquid is aspirated into the pipette.

It is recommended to draw a slightly greater liquid volume than required (due to meniscus above the required volume mark), adjusting the aspiration speed, particularly in the final filling stage, so as not to overfill the pipette.

### Setting the volume

After aspirating the liquid to the pipette, in order to remove the solution rests from the outside surface of the pipette, its end shall be dried with absorbent paper that does not leave impurities. Then set the required liquid volume precisely. Pressing the dispense button gently (fig. 3C), dispense the excessive liquid from the pipette until the meniscus of the liquid aligns exactly with the required volume mark on the pipette.

### Emptying the pipette

Holding the vessel in inclined position, place the pipette end in contact with the vessel wall and press the dispense button gently (fig. 3C). The dispensing intensity may be adjusted depending on how deep the dispense button has been pressed. The deeper the button is pressed the faster the outflow of liquid from the pipette.

The **FASTPETTE PRO** has two dispense modes. The dispense mode is selected by successive pressing the MODE switch (fig. 1D) until the display shows the right mode (fig. 1E).

- dispense in gravity mode marked with the „drop” icon on the display (fig. 2.4) - the dispense is effected in gravity mode, which means that the liquid flows out of the pipette by its own weight. The outflow speed is adjusted depending on how deep the dispense button has been pressed.
- forced dispense with a blow marked with the „arrow” icon on the display (fig. 2.5) – the dispense is effected in gravity mode, however, when the dispense button is pressed to the middle position, the pump is started and fast emptying of the pipette with a blow is effected.

### CAUTION:

During gravimetric dispensing the pipette is not completely emptied due to the characteristics of pipettes used with the pipette controller.

## 6 - TROUBLESHOOTING

If during your work the functioning of the pipette controller is incorrect, check the cause and remove the fault.

Problem	Possible cause	Action
The pipette falls out (the holding force of the pipette is too small), or tilts to the side too much.	The pipette holder is dirty or wet (fig. 1G).	Take out the pipette holder, clean, wash and dry.
	The pipette holder is damaged.	Replace the holder with a new one.
The pump is working, but the pipette controller does not draw liquid or draws liquid very slowly.	The filter is dirty (fig. 1H).	Take out the pipette holder, take out the filter, if it is dirty, replace it with a new one.
	The pipette holder and/or the connector gasket is damaged (fig. 1J).	Replace the mechanically damaged elements with new ones.
Liquid leaks from the pipette (the aspiration and the dispense buttons are not pressed)	The pipette is damaged.	Check the pipette for damage - cracks, dents - if present, replace the pipette with a new one.
	The pipette is inserted incorrectly.	Check whether the pipette has been correctly inserted in the holder.
	The pipette holder, the filter, or the connector gasket is installed incorrectly.	Check whether all parts are present and correctly installed.
	The pipette holder and/or the connector gasket is damaged (fig. 1G, fig. 1J).	Replace the mechanically damaged elements with new ones.

If the problem cannot be remedied using the above guide, contact Labnet International to obtain service.

Before returning the **FASTPETTE PRO** for service, it should be cleaned and decontaminated. A decontamination form and RA number must be obtained from Labnet before sending for service.

## 7 - REPLACING THE FILTER

### CAUTION:

The work safety instructions given in section 2 shall be observed when disassembling the pipette controller.

The filter replacement is necessary, if drawing efficiency deterioration is observed. The direct reason may be dirty filter after a long period of use.

The procedure is shown in fig. 4.

- Remove the pipette.
- Unscrew the nosepiece (fig. 4A).
- Remove the membrane filter (fig. 4A) and the pipette holder (fig. 4B).
- Rinse the holder using a wash bottle (fig. 4C).
- Blow liquid out of the holder and leave it until it is completely dry.
- Install new membrane filter (fig. 4D) and assemble the device in reverse order.

## 8 - CHARGING THE BATTERIES

### CAUTION:

The **FASTPETTE PRO** may be charged only with the original charger. The mains voltage must conform with the specification on the charger.

Using other chargers than the original one may damage the battery of the pipette controller.

Charging the batteries in the **FASTPETTE PRO** pipette controller is controlled by a micro-processor chip which controls the entire process. When the batteries have been charged, the charging circuit disconnects automatically.

### Charging:

1. Charging temperature: 10 °C to 35 °C.
2. Charging is carried out through a charger (power supply) by direct connection to the mains, or indirectly by means of a charging stand (fig. 1M). Batteries charging is indicated by successive lighting of "bars".
3. Full charging time: 7-8 hours.
4. The batteries are charged when all 3 "bars" are displayed simultaneously (fig. 5.1).

The pipette controller has 3 NiMH type AAA batteries.

You have access to the batteries (fig. 1L) and can replace them with new ones after taking off the battery cover (fig. 1K). The manner in which the batteries are arranged is shown in fig. 8.

The service life of the batteries: approx. 1000 charging cycles, if used correctly.

It is not possible to overcharge the batteries if all instructions of the manufacturer are followed.

In order to prolong the life span of the rechargeable batteries, the following rules should be followed:

# FASTPETTE PRO

1. Before the pipette controller is activated for the first time, the batteries should be charged.
2. **FASTPETTE PRO** should not be left uncharged for a longer period of time.
3. In the case of a planned longer break in the work of the pipette controller, it is recommended to take the batteries out of the pipette controller.

## 9 - MAINTENANCE

### Cleaning

The **FASTPETTE PRO** does not require any maintenance. The external parts of the pipette controller may be cleaned with a swab moistened with isopropyl alcohol.

The nosepiece and the pipette holder may be autoclaved at 121 °C for 20 minutes. After autoclaving, dry the pipette holder. The filter included in the set may be sterilised by autoclaving at 121°C for not more than 15 minutes.

### Storage

The **FASTPETTE PRO** shall be stored in a dry place. The allowable storage temperature: -20 °C to +50 °C.

During breaks in the work the pipette controller shall be placed on a charging stand in horizontal position (fig. 7A) or in vertical position (fig. 7B). The charging stand may be fitted on a wall (fig. 7B) with a fixing set included with the pipette controller.

### CAUTION:

Do not store the pipette controller with a filled pipette.

## 10 - COMPONENTS

The **FASTPETTE PRO** set is supplied with the following components:

- Pipette controller
- Charger
- Charging stand
- Membrane filter 0.2 µm
- Battery – 3 pcs.
- Instruction manual

## 11 - ORDERING INFORMATION

The **FASTPETTE PRO** comes with a universal charger and a set of adapters in different versions: EU, US, UK and Australia. Choose your country used adapter and connect to the housing.

To mount the adapter, it should be inserted into the slots of the housing in the direction of the arrow (1), until you hear a click engagement.

To remove or change the adapter, simply press the “PUSH” button in the direction of the arrow (2), then holding the button down, remove the adapter in the direction of the arrow (3).

**Catalogue no. P2002**

## 12 - SPARE PARTS

Item in fig. 1	Part name	Catalogue no.	Number of pieces in pack
F	Nosepiece	P29052	1
G	Pipette holder	P29054	1
H	Membrane filter 0.2 µm	P9023	1
	Membrane filter 0.45 µm	P9024	1
J	Connector gasket	P9025	1
L	Battery - NiMH	P29066	3
M	Charging stand	P29055	1
N	Charger 9V: EU, US, UK, AU	P9010	1

## 13 - PRODUCT DISPOSAL

According to Directive 2012/19/UE of the European Parliament and of the Council of 4 July 2012 on waste electrical and electronic equipment as amended, pipette controller **FASTPETTE PRO** is marked with the crossed-out wheeled bin and must not be disposed of with domestic waste.



In accordance with the requirements of Directive 2006/66/EC of 6 September 2006 on batteries and accumulators and waste batteries and accumulators, batteries must be disposed of in accordance with national regulations.

The crossed out wheeled bin symbol is printed in the product instruction manual and on the packaging. In order to recycle the used product, send it to the nearest service centre or to the manufacturer. For contact details please go to [www.labnetinternational.com](http://www.labnetinternational.com)

All rights reserved. Product described in this manual is subject to availability and technical modification. Errors excepted. LABNET reserves the right to improve, enhance or otherwise modify its products without prior notification. © 2014 LABNET

FPPR/11/2014/I

Made in Poland