

EDP-Plus™

Electronic Pipette

9 pipettes for
volume ranges
from
0.5 μL to 10 mL

250 μL EDP-Plus shown



RAININ

Contents

Section 1	Description	1
Section 2	Unpacking and Set-up	1
Section 3	Basic Operation	4
Section 4	Optional Settings	12
Section 5	Setting Speeds	13
Section 6	Advanced Operation	14
Section 7	Proper Pipetting Technique	18
Section 8	Changing Liquid Ends	19
Section 9	Removing the Tip Ejector	21
Section 10	Care and Maintenance	21
Section 11	Troubleshooting	26
Section 12	Performance Specifications	27
Appendix A	Charging the Battery Pack	28
Appendix B	Ordering Information	29

FIGURES AND TABLES

Figure 1-1	EDP-Plus Controls and Indicators	1
Figure 2-1	Display after Initialization Sequence	2
Figure 2-2	Installing the Battery Pack	3
Figure 3-1	Holding the EDP-Plus Pipette	4
Figure 3-2	Resuming Operation after Auto Shut-Off	5
Figure 8-1	Volume Markings on Liquid End	19
Figure 8-2	Removing the Liquid End	19
Figure 8-3	Attaching the Liquid End	20
Figure 8-4	Display after Initialization Sequence	20
Figure 9-1	Removing the Tip Ejector	21
Figure 10-1	Typical Piston Seal Assembly	22
Figure 10-2	Removing the Piston Assembly from the Liquid End	23
Figure 10-3	2.5 mL Liquid End, Removing the Piston Seal	23
Figure 10-4	10 mL Liquid End Assembly	24
Figure A-1	Connecting Wall Power Supply	28
Figure A-2	Rapid Charge Stand Accessory	28
Table 3.1	EDP-Plus Basic Operation	4
Table 5.1	EDP-Plus Programmable Speeds	13
Table 6.1	EDP-Plus Advanced Functions	14
Table 12.1	EDP-Plus Specifications	27

EDP-Plus Electronic Pipettes use a motorized linear actuator to move the piston. The linear actuator, controlled by a miniature onboard computer, moves the piston the correct distance, at the correct speed, every time. Piston strokes are consistent and reproducible.

Each complete EDP-Plus pipette includes a control module, a wall power supply, and a replaceable liquid end. The control module is the same for all volume ranges; an encoder plug tells the control module which liquid end is attached. Extra liquid ends with encoders can be purchased separately.

A precisely machined chrome-plated stainless steel piston* is moved by an electronic linear actuator. The piston displaces a column of air which picks up or dispenses liquid through a disposable polypropylene tip. This tip is the only part of the instrument that touches the liquid. A mechanical tip ejector** allows tips to be changed easily without hand contact, avoiding sample carryover and contamination.

You enter mode, volume, and speed settings into the microcomputer through a keyboard. Operational status and settings are shown on an easy-to-read LCD (liquid crystal display). Audible tones signal completion of piston strokes and error conditions. Pickup and dispense are performed by pressing the trigger.

Power can be supplied to the EDP-Plus pipette in either of two ways: with a cord attached to a wall power supply, or with an rechargeable Battery Pack for maximum convenience and freedom of movement.

With a fully-charged Battery Pack installed, the EDP-Plus will operate for more than 1000 full-stroke cycles before recharging is needed.



FIGURE 1-1
EDP-PLUS CONTROLS AND
INDICATORS

* The piston in the 10 mL liquid end is polished stainless steel, not chrome-plated.

** Except 2.5 mL and 10 mL liquid ends.

Unpacking and Set-up

UNPACKING

In addition to this manual, your EDP-Plus package should contain:

1. EDP-Plus Electronic Pipette
2. Wall Power Supply

Before using your EDP-Plus, inspect each component for damage sustained in transit. If you find damage, file a claim immediately with the shipping carrier. Save the shipping container until any damage claim is resolved and the instrument is checked and operates properly.

WARRANTY

Complete and return the Warranty Registration Card. All EDP-Plus Electronic Pipettes carry a one year warranty against defects in materials and workmanship. Physical and chemical abuse are not covered. For information regarding the warranty or repair of any instrument, please call RAININ at 800-543-4030, e-mail: pipets@rainin.com, www.rainin.com

Outside the U.S.A., local warranty conditions may apply. Contact your Rainin distributor: see www.rainin-global.com or e-mail global@rainin.com.

NOTE: If the equipment is used in a manner not specified, the protection provided by the equipment may be impaired.

Warranty returns are only accepted with prior authorization.

SET-UP

Connect the wall power supply to a power outlet matching the line voltage printed on the label (105-130 VAC/50-60 Hz, or 210-260 VAC/ 50-60 Hz). Then plug the cord from the power supply into the socket on the back of the control module.

The EDP-Plus pipette will execute its initialization routine. After about 5 seconds the instrument will be in PIPETTE mode and the display should be as shown in Figure 2-1. If not, refer to the Troubleshooting Guide in Section 11 of this manual.

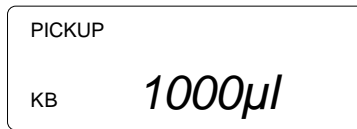

FIGURE 2-1 DISPLAY AFTER INITIALIZATION SEQUENCE (EP-1000 SHOWN)

Your EDP-Plus pipette is now ready for use. If you have purchased the Battery Pack Accessory, install it into the control module as described in the following pages.

NOTE: EDP-Plus can be used without a power cord when the Battery Pack is installed. However, before installing the Battery Pack, it is a good idea to test operation with the wall power supply, to see that the pipette works correctly.

WARNING:

This equipment generates and uses radio frequency energy and if not installed and used properly, i.e. in strict accordance with the instruction manual, may cause harmful interference to radio communications. It has been tested and found to comply with the limits for a Class A computing device pursuant to Subpart J of Part 15 of FCC rules, which are designed to provide reasonable protection against such interference when operated in a commercial environment.

Operation of this equipment in a residential area is likely to cause interference, in which case the user at his own expense will be required to take whatever measures may be required to correct the interference.

INSTALLING THE BATTERY PACK

The Battery Pack compartment is at the rear of the control module. Slide the battery compartment cover left to remove it. Carefully pull the male connector clear, shown below .

Align the male and female connectors, noting the pin pin arrangement: one pin, space, two pins. Fasten the connectors together, but do not force them. Insert the Battery Pack into the control module as indicated on the label. Replace the compartment cover.

If the pipette does not initialize when power is supplied, but worked normally when connected to the wall power supply, the Battery Pack may have discharged in transit. See Appendix A – Charging the Battery Pack.

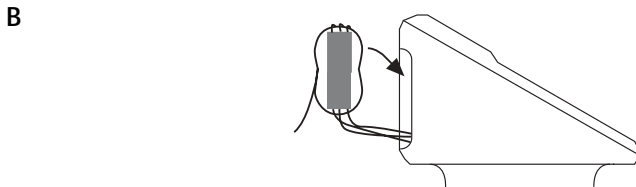
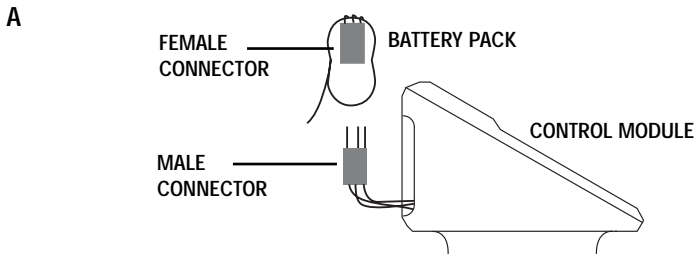

Connect the male connector to the female connector on the new battery pack, and rotate the battery pack into the control module as shown by the arrow.

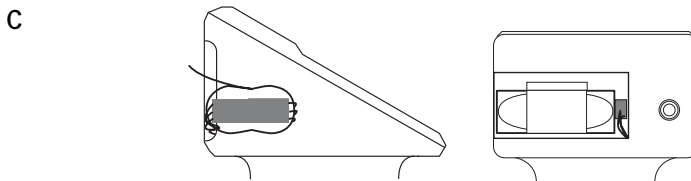

Push the battery pack into the control module as far as possible, as shown at left. Push the wires to the right of the battery as shown at right. Replace the battery door and slide it closed.

FIGURE 2-2 INSTALLING THE BATTERY PACK

If you have any questions regarding this procedure, call Technical Support: 800-543-4030.

EDP-Plus can operate in five modes:

MODE	KEY	DESCRIPTION
P: PIPETTE	F 1	A single volume is picked up and dispensed.
M: MULTIPLE DISPENSE	F 2	A single volume is picked up and multiple volumes dispensed stepwise.
T: TITRATE	F 3	A single volume is picked up and partially dispensed under trigger control.
D: DILUTE	F 4	Diluent and sample are picked up separately and dispensed together.
MEAS: MEASURE	F 5	A sample is picked up under trigger control and its volume is displayed.

Table 3.1 – EDP-Plus Basic Operation

Modes are selected in EDP-Plus by holding the F key and a number key as shown in the table above. The keyboard shows the name or initial of the mode. See sketch to right:

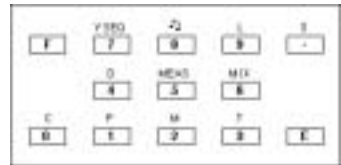

The instrument powers up in PIPETTE mode. You can change modes when:

1. The piston is in the HOME position and **KB** is displayed. (If necessary, press the FUNCTION key **F** and then **0** to clear the current operation and move the piston to HOME. **KB** should then appear on the display.)
2. The keyboard is not locked. (Press **F 9** to unlock.)

To change modes press **F** then the appropriate number key. For example, to open TITRATE mode press **F 3**. For MULTIPLE DISPENSE mode, press **F 2**.

The EDP-Plus pipette has been designed to be easy to use whether you are right- or left-handed. The balance, weight, comfortable "feel", and light touch of EDP-Plus make it ideal for continuous use.

Hold EDP-Plus loosely as shown in Figure 3-1. You do not need to grip the pipette tightly during operation. Operate the trigger with your index finger and the tip ejector button with your thumb. Because there is no need for thumb pressure during pick up, dispense, and blowout, operator fatigue is greatly reduced compared to manual pipettes.



FIGURE 3-1
HOLDING EDP-PLUS

AUTO SHUT-OFF

The EDP-Plus pipette shuts itself off automatically if none of the keys or the trigger are pressed for three minutes. If the display is blank and the trigger does not work while power is supplied, EDP-Plus is shut off. Press any of the top row keys or E to turn on the instrument.

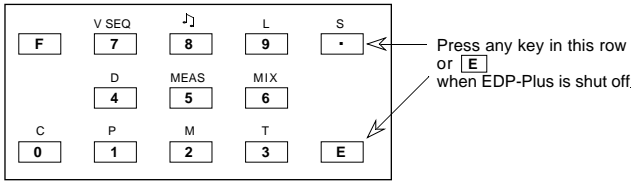

FIGURE 3-2 RESUMING OPERATION AFTER AUTO SHUT-OFF

EDP-Plus remembers current operational settings when "shut-off", and will resume operation at the same point and with the same settings as when last used, as long as power to the instrument has not been interrupted.

This feature is provided to extend the life of the Battery Pack accessory.

BASIC OPERATION

The examples used in this manual show the display for EP-1000 (EDP-Plus with 1000 μ L nominal volume). Your instrument will operate in the same way, but volumes shown will be different if your pipette has a different nominal volume.

Attach a disposable tip by pressing the liquid end shaft firmly into the tip. Use water as your sample until you are familiar with the EDP-Plus pipette.

QUICK REFERENCE: PIPETTE MODE

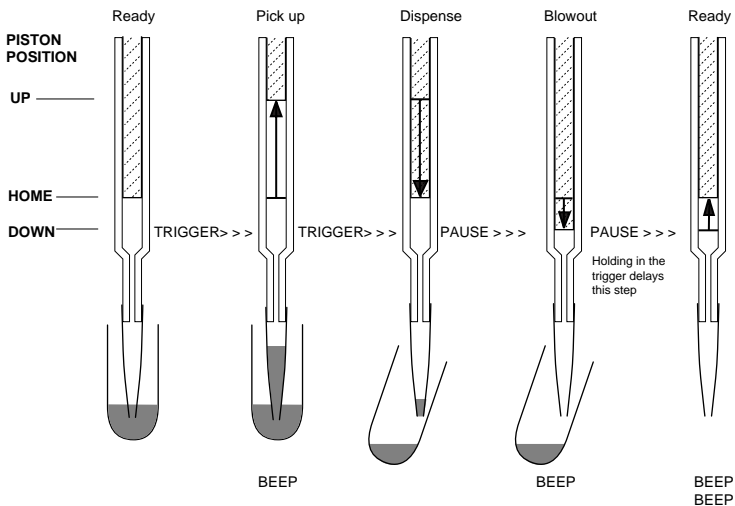

PIPETTE MODE F 1

When power is supplied, EDP-Plus executes a five-second initialization sequence and opens in PIPETTE mode. The display will show the nominal volume.

SETTINGS

Press number keys then the **E** (Enter) key to change the volume. The display will flash on and off. If you make a mistake, set a new volume then press **E** .

OPERATION



PICKUP VOLUME



DISPENSE VOLUME

1. Press and release the trigger* to pick up the displayed volume. You will hear a "beep" at the end of the piston stroke. See diagram at left.
2. Press and release the trigger again to dispense the liquid. See diagram at right.

The piston moves to HOME, then rapidly executes a blowout stroke. You will hear a beep at the end of the blowout. After a one-second delay the piston returns to HOME ready for the next pickup. This is signalled by two beeps**.

The one-second delay is to give you time to remove the tip from the dispense vessel before the piston returns to HOME position. You can extend the delay by holding in the trigger as the sample is dispensed.

When EDP-Plus is in any other mode, open PIPETTE mode as follows:

a. Press **F 0** . This action will clear the current operation and move the piston to HOME position. **KB** will show on the display, indicating the piston is HOME. (Check the keyboard is not locked. If locked, press **F 9** to unlock it.)

b. Press **F 1** to open PIPETTE mode.

The display will show the nominal volume unless you have previously set a volume in PIPETTE mode. (In all modes, any previously entered volume is remembered by EDP-Plus as long as power is supplied continuously.)

* Holding the trigger in postpones the next step in all modes except TITRATE, MEASURE, and MIX.

** Each piston stroke is signalled by a short beep when the tone generator is turned on. End-of-stroke beeps will not be included in the following descriptions.

QUICK REFERENCE: MULTIPLE DISPENSE MODE

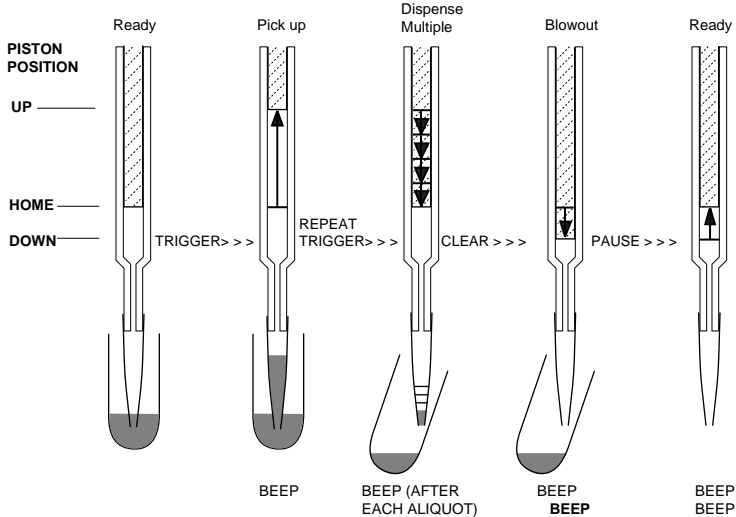

MULTIPLE DISPENSE MODE F 2

Make sure the piston is at the HOME position (KB shows on display) and the keyboard is not locked. Open MULTIPLE DISPENSE mode by pressing **F 2**.



MULTIPLE DISPENSE NOMINAL VOLUME

SETTINGS

1. The nominal pickup volume (or previously stored value) is displayed. Press **E** to check or change the dispense volume.
2. Press number keys to set or change the dispense volume. While pressing keys, the entry flashes until **E** is pressed. See DISPENSE VOLUME, below
3. The instrument calculates and flashes the largest number of whole aliquots which will divide into the nominal volume. You can accept this aliquot number by pressing **E**, or you can change to a smaller number by pressing number keys, then **E**.

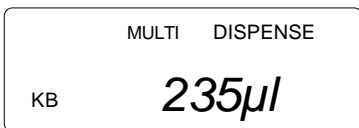

DISPENSE VOLUME

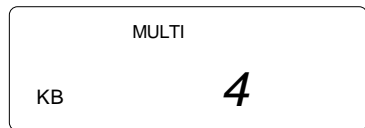

NUMBER OF ALIQUOTS (FLASHING)

4. The instrument calculates and displays the volume needed to pick up all aliquots.

TOTAL PICKUP VOLUME

PICKUP	MULTI
KB	940µl

OPERATION

1. Press and release the trigger to pick up the displayed volume.
2. Press and release the trigger again to dispense the first aliquot. Continue pressing and releasing the trigger until all aliquots are dispensed.
3. Press **0** to clear the instrument, discarding the residual volume left in the tip.

After the dispense volume is entered, EDP-Plus calculates the pickup volume:

$$\text{Pickup Volume} = (\text{Number of Aliquots} \times \text{Dispense Volume}) + \text{Residual Volume}$$

When the calculated volume is picked up, the piston slightly overshoots and then returns to its proper pickup position, to ensure accuracy of the first aliquot dispensed. To ensure that the last aliquot will be accurate, the fixed residual volume remains in the tip after all aliquots have been dispensed and must be discarded by pressing **0** before making the next pickup stroke.

QUICK REFERENCE: TITRATE MODE

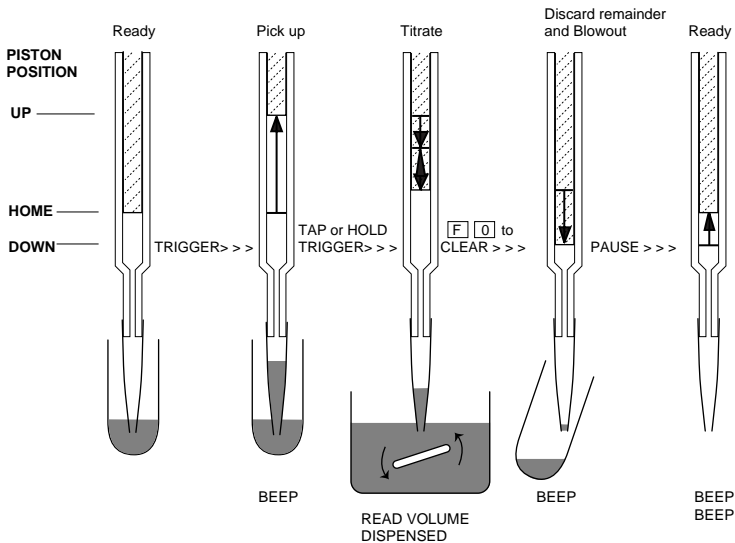

TITRATE MODE F 3

Make sure the piston is at the HOME position (KB shows on display) and the keyboard is not locked.

Open TITRATE mode by pressing **F 3** .



SETTINGS

1. The display shows the nominal pickup volume. To change the pickup volume, enter a new initial pickup volume with the number keys and press **E** .



2. To set an initial dispense volume, press number keys then press **E** . (To set an initial dispense volume without changing the initial pickup volume, press **E** first. Enter the volume with number keys. Then press **E** again.)

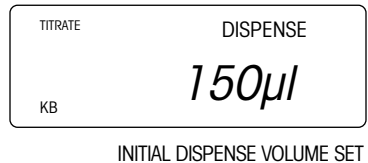

OPERATION

1. Press and release the trigger to pick up the initial volume.
2. To begin titration, press and hold the trigger to dispense liquid first slowly, then at an increasing rate. The longer the trigger is held, the faster the liquid is dispensed. Release and hold in the trigger again to restart dispensing at the slowest rate. To dispense one increment at a time, tap the trigger.
3. When the desired endpoint is reached, read and record the dispensed volume from the display. Then clear the instrument by pressing **F 0** . This will discard the remainder in the tip and return EDP-Plus to its starting position.

If the entire volume is titrated, press the **0** key when the beep sounds and the display reads "CLEAR". This action will execute the blowout stroke and empty the residual volume from the tip.

In TITRATE mode, a small residual volume is left in the tip after the entire volume has been titrated. The residual volume ensures that the volume titrated is accurate. **The residual volume is not part of the titrated volume and must be discarded by pressing F 0 .**

QUICK REFERENCE: DILUTE MODE

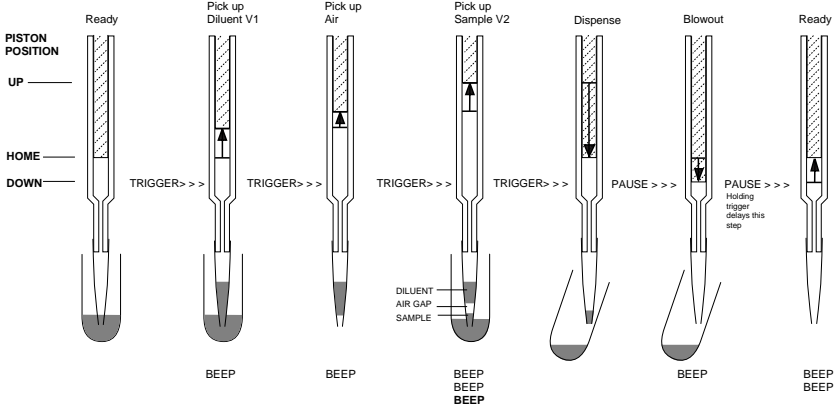

DILUTE MODE F 4

Make sure the piston is at the HOME position (**KB** shows on display) and the keyboard is not locked. Press **F 4** to open DILUTE mode. The display will show the default diluent volume, which is 90% of nominal volume. (The default sample volume is 10% of nominal volume, for 10:1 dilution.)

SETTINGS

1. Set the diluent volume (V_1) by pressing number keys then **E**.



2. Set the sample volume (V_2) in the same way.

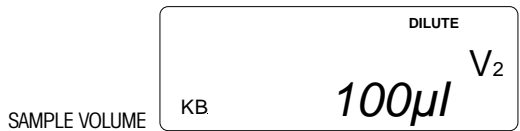

OPERATION

1. Press and release the trigger to pick up the diluent.

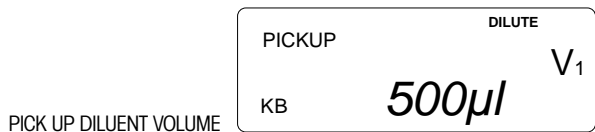

2. Press and release the trigger to pick up an air gap*.



3. Press and release the trigger a third time to pick up the sample.



4. A three-part tone sounds, indicating that diluent and sample are separated by the air gap, ready to be dispensed. Press and release the trigger to dispense diluent and sample.



DISPENSE DILUENT AND SAMPLE TOGETHER

5. The display shows the diluent volume, ready for the next cycle.

* When using DILUTE mode with the 10mL liquid end, the air gap will probably rise through the diluent and allow diluent and sample to mix in the sample reservoir. To avoid this, you can use VOLUME SEQUENCING in DILUTE mode. Then set a smaller air gap, or no gap, as desired. See Section 6 — Advanced Operation: VOLUME SEQUENCING.

QUICK REFERENCE: MEASURE MODE

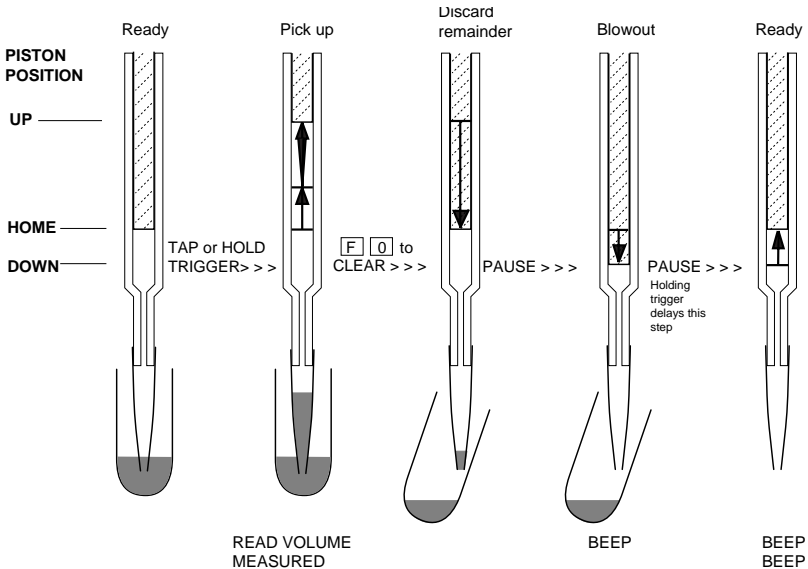

NOTES:

1. An initial pickup volume can be set.
2. Piston direction can be changed by pressing 0, even while the trigger is pressed.
3. At full stroke (or at zero) the trigger must be released. Then either press F 0 to clear the pipette, or press the trigger again to reverse piston direction.

MEASURE MODE F 5

Make sure the piston is at the HOME position (**KB** shows on display) and the keyboard is not locked. Press **F 5** to open MEASURE mode.

SETTINGS

The display reads "0µl" (or any previously entered initial pickup volume). You can enter an initial pickup volume if you wish by pressing number keys then **E**.

OPERATION

1. Press and hold the trigger to pick up. Pickup speed increases until it reaches the maximum. Release the trigger and press it again to restart at the slowest rate. To pick up one increment at a time, tap the trigger. (Any initial pickup volume is picked up at the first trigger press. Hold the trigger in to continue measurement.)

When the desired volume of liquid has been picked up, ensure the lower level of the liquid is flush with the tip orifice (no air has been included) and read the volume on the display.

The piston direction can be reversed at any time by pressing **0**. (This is useful if an air bubble is picked up; pressing **0** reverses the flow, expelling the bubble. Pressing **0** again reverses flow and continues measurement.) The display always shows the current volume in the tip as well as the piston direction, either PICKUP or DISPENSE.

2. At full- or zero-scale, the display reads "CLEAR" and the trigger must be released.

Press the trigger again to reverse direction automatically. (The pipette may be cleared and the tip contents dispensed by pressing **F 0**; this is useful if the volume of liquid to be picked up exceeds the full-scale volume of the instrument.)

Optional Settings

4

TONE GENERATOR CONTROL F 8

A tone generator in the EDP-Plus signals operational status or error conditions as follows:

<u>Status</u>	<u>Tone sound</u>	<u>Tone description</u>
Initialization	BEEP-BEEP	Two short beeps
Key press	BIP	One very short beep
End of pickup stroke	BEEP	One short beep
End of dispense stroke	BEEP	One short beep (lower tone)
Piston at HOME	BEEP-BEEP	Two short beeps
End of pickup in DILUTE mode	BEEP-BEEP-BEEP	Two short, one long beep
Error condition/Low battery*	DEE-DAH-DEE-DAH	High warble

* Works even when tone generator is OFF

Tones are automatically switched on when the instrument is powered up. To switch off the tones, press **F 8**. Pressing **F 8** again turns the tone generator back on.

KEYBOARD LOCK CONTROL F 9

The EDP-Plus keyboard can be locked if desired. This feature is for protection. Locking the keyboard prevents unwanted volume or mode changes when the EDP-Plus is used for the same task over an extended period.

To lock the keyboard, press **F 9** when the keyboard is active (when **KB** is displayed). Press **F 9** again to unlock the keyboard. When the keyboard is locked, all keystrokes are ignored except **F 0** (clear), **F 8** (tone generator control), and **F 9** (keyboard lock/unlock). The trigger operates whether the keyboard is locked or unlocked.

Setting Speed

5

PROGRAMMABLE SPEED F •

You can program the pickup and dispense speed of the EDP-Plus pipette to accommodate almost any liquid, including moderately dense or viscous liquids.

The default speed setting for EDP-Plus pipettes is 8*. This fast setting is optimized for liquids with similar physical properties to water. However, you may wish to set a higher speed for even faster operation or a slower speed for more dense or viscous liquids.

To reset the speed, press **F •** (decimal point) then press a number between 0 and 9, then press **E**. The display reverts to show volume after speed has been set. The table below shows cycle component times for available speed settings.

Table 5.1 – EDP-Plus Programmable Speeds

Speed Setting	Full-Scale Pickup	Full-Scale Dispense	Delay before Blowout	Blowout duration	Dwell Time (constant)
9	1.3 sec.	1.3 sec.	0.0 sec.	0.13 sec.	1.0 sec.
8	1.3 sec.	1.3 sec.	0.5 sec.	0.13 sec.	1.0 sec.
7	1.3 sec.	1.3 sec.	1.0 sec.	0.13 sec.	1.0 sec.
6	2.2 sec.	2.2 sec.	0.5 sec.	0.22 sec.	1.0 sec.
5	2.2 sec.	2.2 sec.	1.0 sec.	0.22 sec.	1.0 sec.
4	2.2 sec.	2.2 sec.	1.5 sec.	0.22 sec.	1.0 sec.
3	2.2 sec.	2.2 sec.	2.0 sec.	0.22 sec.	1.0 sec.
2	4.4 sec.	4.4 sec.	0.5 sec.	0.44 sec.	1.0 sec.
1	4.4 sec.	4.4 sec.	1.0 sec.	0.44 sec.	1.0 sec.
0	4.4 sec.	4.4 sec.	2.0 sec.	0.44 sec.	1.0 sec.

This table does not apply to trigger-controlled actions in TITRATE and MEASURE modes.

* Default speed setting for EDP-Plus 10ML and M8 models is 5. Speed range is from 0 – 6.

Table 6.1 – EDP-Plus Advanced Functions

FUNCTION	KEY	DESCRIPTION	APPLICABLE MODE
MIX	F 6	Mixes by repeated up-and-down piston motion while trigger is held in	P – PIPETTE D – DILUTE
VOLUME SEQUENCING	F 7	<p>PIPETTE: up to 12 distinct volumes can be picked up and dispensed sequentially.</p> <p>MULTIPLE DISPENSE: up to 12 distinct volumes can be dispensed sequentially from a single pickup volume.</p> <p>DILUTE: up to 12 distinct volumes can be picked up sequentially and dispensed together.</p>	<p>P – PIPETTE</p> <p>M – MULTIPLE DISPENSE</p> <p>D – DILUTE</p>

MIX F 6 Available in PIPETTE and DILUTE modes only.

SETTINGS

1. Open the MIX function by pressing **F 6** .
2. The display prompts you for a mix volume*. Enter this volume and press **E** .



MIX VOLUME ENTERED

OPERATION

1. (PIPETTE mode) Press and release the trigger to aspirate the pickup volume. Press the trigger again to dispense.

(DILUTE mode) Press and release the trigger to pick up the diluent. Press and release the trigger to pick up an air gap, and again to pick up the sample. When the three-part tone sounds, press the trigger once more to dispense diluent and sample together.

* The mix volume may be larger than the pickup or diluent/sample volumes.

2. Hold the trigger (either during or after the dispense stroke) to start mixing. Mixing will continue as long as the trigger is held in. The display alternates between PICKUP and DISPENSE while mixing is in progress.



MIXING IN PROGRESS; MIX VOLUME ALTERNATELY PICKED UP AND DISPENSED

3. Release the trigger. Mixing stops and a normal blowout stroke occurs. The display shows the pickup or diluent volume, ready for another cycle.

4. To close the MIX function press **F 6** .

VOLUME SEQUENCING F 7 in PIPETTE, MULTIPLE DISPENSE, and DILUTE modes.

VOLUME SEQUENCING: PIPETTE MODE

In PIPETTE mode, up to twelve distinct volumes can be picked up and dispensed sequentially with VOLUME SEQUENCING.

When using this function, you are not restricted to the fixed sequence: by pressing the **F 0** keys you can go back and repeat the previous volume, or by pressing **E** you can skip over the next volume. The sequencing cycle can be started at any point. Open the VOLUME SEQUENCING function by pressing **F 7** .

SETTINGS

Display flashes "0µl" (or the volume last set). Set the first pickup/ dispense volume (V1) by pressing number keys followed by **E** . Continue setting sequential pickup/dispense volumes. Press **0 E** to end the sequence. If you enter all twelve volumes, you do not have to press **0** to end the sequence. Sequential volumes are numbered as follows: V₁₋₉, then V_A (10), V_b (11), & V_C (12).

OPERATION

1. Press and release the trigger to pick up the current volume.



FIRST VOLUME PICKED UP

2. Press and release the trigger to dispense the current volume.

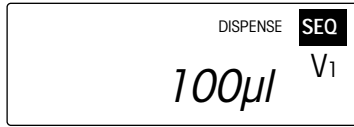

1ST VOLUME DISPENSED

3. Press and release the trigger to pick up the next sequential volume.



2ND VOLUME PICKED UP

4. Press and release the trigger to dispense the next sequential volume. Continue in this way until all volumes are picked up and dispensed.
5. After the last volume in the sequence is dispensed, the first volume is displayed again, ready for pickup.
6. To close the VOLUME SEQUENCING function, press **F 7**.

VOLUME SEQUENCING: MULTIPLE DISPENSE MODE

In MULTIPLE DISPENSE mode with VOLUME SEQUENCING, up to 12 distinct volumes can be dispensed sequentially from one pickup volume. Open the VOLUME SEQUENCING feature by pressing **F 7**.

SETTINGS

1. The display flashes "0µl" (or the volume last set). Enter the first volume (V1) with the number keys and press **E**.
2. The display flashes "0µl" again, prompting you for the next volume. Enter the second volume (V2) and continue in the same way for each entry, finishing each entry with **E** and the last entry with **0 E**. Sequential volumes are numbered as follows: V₁₋₉, then V_{A (10)}, V_{b (11)}, & V_{C (12)}.
3. The EDP-Plus pipette calculates and displays the number of cycles, or the largest number of times the sum of the volumes will divide into the nominal volume of the instrument. Accept the number of cycles by pressing **E**, or set a smaller number and press **E**. (Setting a larger number will sound an error alarm.)

OPERATION

1. The display will show the volume to be picked up; press and release the trigger to pick up that volume.

2. The next trigger press will dispense the first sequential volume. The next trigger press will dispense the second sequential volume, and so on.
3. After all sequential volumes in the first cycle have been dispensed, press the trigger to begin the second cycle. Continue until all cycles are complete.
4. The display will read "CLEAR" after the last dispense volume in the last cycle. Press **0** to clear the instrument.
5. To close the VOLUME SEQUENCING function, press **F 7**.

VOLUME SEQUENCING: DILUTE MODE

In DILUTE mode with VOLUME SEQUENCING, up to twelve distinct volumes can be picked up sequentially and dispensed together. Open VOLUME SEQUENCING by pressing **F 7**.

SETTINGS

1. Display flashes "0 μ l" (or volume last set). Press number keys then **E** to set the first sequential volume (V1).
2. Display flashes "0 μ l" (or volume last set). Press number keys followed by **E** to set the next volume (V2). Sequential volumes are numbered as follows: V₁₋₉, then V_{A(10)}, V_{b(11)}, & V_{C(12)}.
3. Continue in this way until all volumes are set. Press **0 E** to end the sequence.

OPERATION

1. The display shows the first pickup volume. Press and release the trigger to pick up the first volume (V1).
2. Press and release the trigger again to pick up the next volume (V2). Air gaps are not automatically added when VOLUME SEQUENCING. If you wish, air gaps can be set as volume entries.*
3. Continue in this way until all volumes are picked up.
4. A three-part tone sounds. Press the trigger to dispense the total volume all at once.
5. The display shows the first pickup volume again. Press and release the trigger to pick up volume V1 and restart the cycle.
6. To close the VOLUME SEQUENCING function, press **F 7**.

* This is a good way to avoid the potential problem when using DILUTE mode with the 10mL liquid end — that of the air gap rising through the diluent, allowing diluent and sample to mix in the sample reservoir. You can set a smaller air gap which will stay in place between the diluent and sample. See Section 3 — Basic Operation, DILUTE mode.

Use RAININ tips

EDP-Plus pipettes are designed for use with RAININ-manufactured disposable tips. Specified performance of EDP-Plus pipettes is guaranteed only when RAININ disposable tips are used as recommended in Section 8. RAININ cannot accept responsibility for damage to EDP-Plus pipettes or for poor performance resulting from the use of other than RAININ disposable tips.

RAININ disposable tips are molded from premium-grade virgin polypropylene plastic. Molds are inspected and maintained frequently to assure high-quality tip production. Samples from each lot of tips are inspected microscopically to assure that every lot meets these high standards. To order Tips for EDP-Plus Pipettes, please refer to the RAININ Pipetting Solutions Catalog or the current RAININ Product Update. Call 800-543-4030 for a free copy of these publications. You can also view or download a PDF version online: http://www.rainin.com/lif_prodlif.asp

Pipetting techniques

EDP-Plus pipettes are designed to deliver accurate and precise measurements under the following conditions:

1. The liquid pipetted is water or liquid with density, viscosity, and vapor pressure similar to water. The temperature of the room, the EDP-Plus, and the liquid, are all in the range $21.5^{\circ}\text{C} \pm 1^{\circ}\text{C}$. The EDP-Plus pipette is kept vertical while pipetting or within 20° of vertical.
2. The end of the disposable tip is immersed beneath the sample surface as follows:
 - 2 to 3 mm – volumes up to 100 μL .
 - 2 to 4 mm – volumes from 100 μL to 1000 μL .
 - 3 to 6 mm – volumes over 1000 μL .
3. There is no significant adherence of liquid to the surfaces of the tip. (Each tip should be rinsed once before pipetting to assure the best precision).
4. When dispensing, the tip is touched to the sidewall of the receiving vessel. At the end of each dispense cycle, the tip is moved along the wall to remove any excess sample from the outside of the tip. A consistent rhythm is maintained from sample to sample when pipetting.

Viscous liquids, such as serum or plasma, can be measured accurately with a slow speed. See Table 5.1 – Programmable Speeds. You can further improve accuracy with viscous solutions by using MULTIPLE DISPENSE mode with the number of aliquots set to 1 and using a slow speed. This method simulates “reverse-mode” pipetting in manual pipettes. In MULTIPLE DISPENSE mode, the volume picked up includes an extra residual volume and the volume of the dispensed aliquot is accurate.

You can measure warm or cold liquids with good precision by using a consistent pipetting rhythm. A consistent rhythm will help minimize any differences in heating or cooling effects within the pipette. Use a new disposable tip each time for best accuracy and precision when measuring samples with temperatures greatly different from ambient, and do not pre-rinse.

As with any air-displacement pipette, best results will be obtained if there is no delay between picking up the sample and dispensing it.

EDP-Plus liquid ends are interchangeable. The liquid end nominal volume is marked in two places, shown in Figure 9-1. The encoder plug is marked on its top surface. The liquid end can be mounted very quickly on the EDP-Plus control module as described below.

Before removing the liquid end, bring the piston to HOME by pressing **F 0** . The letters **KB** should appear on the display. If the keyboard is locked, unlock it (press **F 9**).

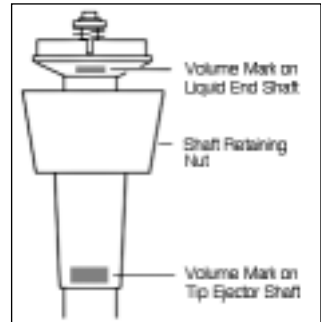

FIGURE 8-1
VOLUME MARKINGS ON LIQUID END

TO REMOVE THE LIQUID END

1. Referring to Figure 8-2a , loosen the shaft retaining nut by rotating it counter-clockwise.
2. When the shaft retaining nut is free of the threads, pull the liquid end away from the control module. (Figure 8-2b.)
3. Remove the encoder plug from the control module (Figure 8-2c) and store it with its matching liquid end. Liquid measurements made with the EDP-Plus will be accurate and precise ONLY when the correct liquid end/encoder plug combination is used.

NOTE: Before storage, disassemble the liquid end and inspect for salts or residues. Clean the liquid end and keep it with its encoder plug. Do not touch the underside of the plug; skin oils can contaminate it, causing poor electrical contact and performance. The plug can be cleaned with isopropanol.

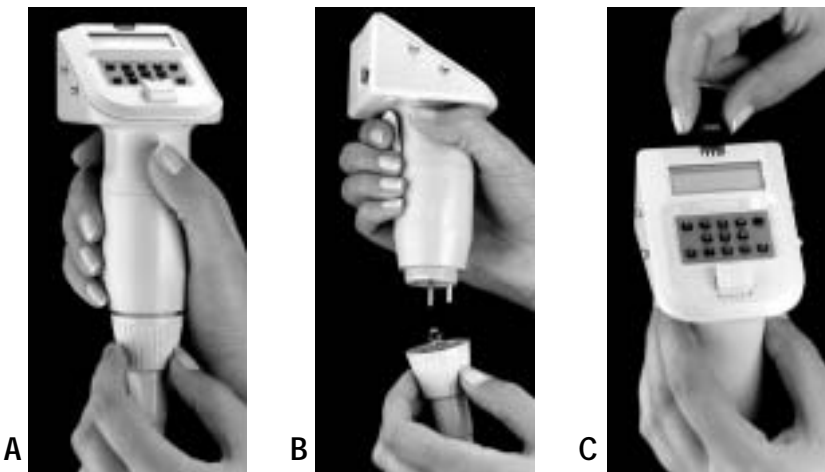

FIGURE 8-2 REMOVING THE LIQUID END

REINSTALLING THE LIQUID END

CAUTION:

Always attach the replacement liquid end BEFORE inserting the encoder plug.

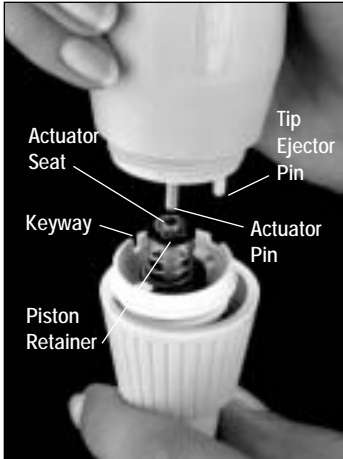

FIGURE 8-3 ATTACHING THE LIQUID END

1. Refer to Figure 8-3. Hold the shaft retaining nut and support the liquid end upright with its end on a smooth soft surface such as a paper towel.
2. Bring the liquid end and the control module together with the control module directly above the liquid end.
3. Engage the actuator pin with the actuator seat on the piston retainer.
4. Push the liquid end toward the control module body and rotate the liquid end so the tip ejector pin on the control module fits through the matching hole on the liquid end shaft. With the tip ejector pin in the proper position, the control module key will be aligned with the keyway on the shaft.

5. Hold the liquid end and control module together and thread the shaft retaining nut onto the control module. Ensure the threads do not cross, and hand-tighten the shaft retaining nut onto the control module.

NOTE: 2.5 mL and 10 mL models do not use tip ejectors. For these models, engage the actuator pin into the piston retainer and thread the liquid end onto the control module. Store the shaft retaining nut and tip ejector spring for use with other liquid ends.

6. Take the replacement encoder plug. Make sure the labels on the plug and liquid end match. Also check the markings on the liquid end (these are shown in Figure 9-1).
7. Align the encoder plug with its slot in the head of the control module (avoid touching the bottom of the plug) and insert the plug squarely. If power is supplied to the EDP-Plus and the keyboard is unlocked, the initialization sequence begins when the encoder plug is in place.
8. After the initialization sequence, look at the display. The EDP-Plus pipette should be in the pipette mode with the display reading PICKUP. The nominal volume of the liquid end is also displayed, as shown in Figure 9-4. (If your display does not show the proper nominal volume, check that the correct encoder plug is installed.)



FIGURE 8-4
DISPLAY AFTER INITIALIZATION SEQUENCE (EP-1000 SHOWN)

Removing the Tip Ejector

9

The EDP-Plus pipette liquid end (except 2.5 mL and 10mL) has a built-in tip ejector, operated by pressing the thumb button. The tip ejector is a hollow spring-loaded moveable shaft surrounding the liquid end and extending up through the shaft retaining nut.

The EDP-Plus pipette is normally operated with the tip ejector in place, allowing disposable tips to be ejected without hand contact. However, when using deep, narrow reservoirs you may wish to operate the pipette without the tip ejector in place.



FIGURE 9-1
REMOVING THE TIP EJECTOR

Refer to Figure 9-1 and remove the tip ejector as follows:

1. Loosen the shaft retaining nut (counter-clockwise).
2. Pull the liquid end (with tip ejector) from the control module.
3. Slip the shaft retaining nut from the tip ejector.
4. Remove the tip ejector from the liquid end, as shown in Figure 10-1, and set it aside until you need it again.
5. Slide the shaft retaining nut over the liquid end.
6. Thread the shaft retaining nut carefully onto the control module threads, and tighten the liquid end in place. Do not overtighten.

CAUTION: Do not press the trigger during this operation.

Care and Maintenance

10

EDP-Plus pipettes are designed to need very little maintenance and should give years of trouble-free service if treated with proper care and the operating recommendations in Section 8 are followed. Also see: RAININ Publication AB-15, Procedure for Evaluating Accuracy and Precision of RAININ Pipettes, available online at <http://www.rainin.com/pdf/ab15.pdf>

The following rules should be strictly observed to keep the mechanism dry and clean.

1. Never allow liquid to enter the shaft where it can contact the piston or seal.
2. Never pick up liquid without a disposable tip attached.
3. Never invert EDP-Plus or lay it on its side with liquid in the tip. Always hold it upright.
4. Never use solvents to clean EDP-Plus. Instead, use a lint-free wipe dampened with water to clean the instrument. Keep the keyboard and encoder plug dry.

SEALS

Periodically each liquid end (except the 10 μ L) should be tested to ensure proper sealing, as follows:

1. Set the nominal volume and attach a disposable tip.
2. Pick up the full volume of water.
3. Hold the instrument upright and observe the tip for 30 to 45 seconds.

There should be no leaks from the tip or droplet formation at the tip orifice. If leakage does occur, the seal between the tip and the shaft may not be airtight.

DISPOSABLE TIP SEAL

Use only RAININ disposable pipette tips as recommended in Section 5. These tips mate exactly with the EDP-Plus liquid end shaft to form airtight seals.

PISTON SEAL

The seal between the piston and the inside surface of the shaft is formed by a PTFE ring and a fluoroelastomer O-ring (except the 10 mL liquid end). The PTFE ring extends through the O-ring, and only the PTFE ring makes contact with the piston. This is shown in Figure 10-1. (The 10 mL piston seal assembly is shown later in this section.)

The O-ring compresses the PTFE ring against the piston to maintain a proper seal even after moderate seal wear, and also forms a stationary seal between the PTFE ring and the shaft.

Periodically you should dismantle the liquid end for inspection and cleaning, as follows:

1. Remove the liquid end from the control module. Do not remove the encoder plug for this procedure.
2. Inside the liquid end, press the spring-loaded piston retainer and rotate it slightly counter-clockwise to release the retainer catch.
3. Pull the piston assembly out of the liquid end (Fig.10-2). The seal should stay attached to the piston. If it remains in the liquid end, invert the liquid end and gently tap it on the bench until the seal drops out.

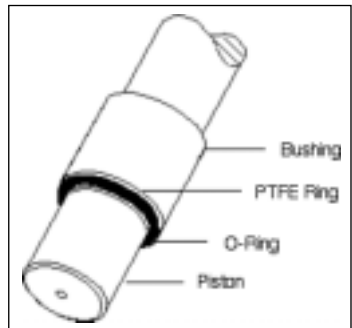

FIGURE 10-1 PISTON SEAL ASSEMBLY

4. Inspect the piston, seal, bushing, and inside of the shaft for any dirt and particulate contamination. There is no need to dismantle the piston assembly any further.

5. Remove any contamination by soaking and rinsing the piston assembly with distilled water or alcohol. The piston surface should have a high-gloss finish. If the finish is dull, scratched, or pitted, the seal may wear very rapidly, and the complete piston assembly should be replaced.

6. Blow the assembly dry with clean dry compressed nitrogen, or dry it with a very soft lint-free wipe. To avoid scoring the piston, do not use rough material such as a paper towel.

CAUTION: Never apply grease to the pipette seal or piston (except 10 mL). Any grease or lubricant may alter the effective diameter of the piston and cause errors in liquid measurement.

REASSEMBLY

1. Make sure the PTFE seal and O-ring are properly positioned on the piston, as shown in Figure 10-1.
2. Place the piston assembly into the liquid end, and compress the piston retainer against the piston spring. Rotate the retainer slightly clockwise to engage the retainer catch.
3. Replace the liquid end on the control module, attach a disposable tip, and test for proper sealing as described in the first part of this chapter.

2.5 mL LIQUID END

The 2.5 mL EDP-Plus piston assembly threads into the shaft and is removed and replaced with a seal wrench (Cat. No. 6100-231).

1. Remove the liquid end from the control module.
2. Place the wrench in the slots in the piston assembly. Turn the wrench counter-clockwise to remove the piston assembly, as shown in Figure 10-3.
3. Clean or replace the seal as described earlier.
4. Reinstall the piston assembly by first inverting the shaft and threading the piston assembly into the shaft. Tighten firmly with the wrench. Do not over-tighten.

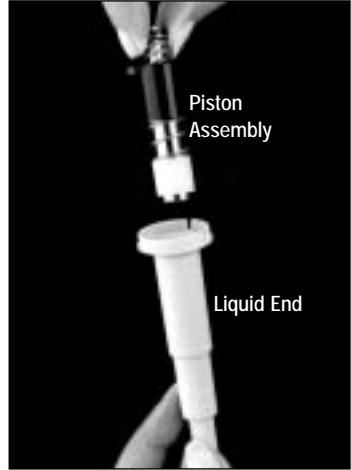

FIGURE 10-2
REMOVING THE PISTON ASSEMBLY
FROM THE LIQUID END

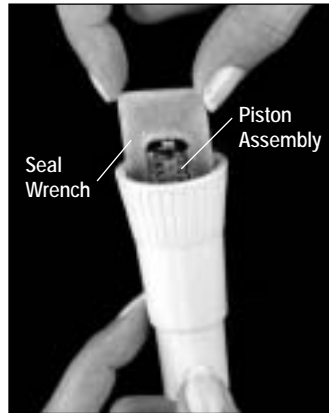

FIGURE 10-3
2.5 mL LIQUID END; REMOVING
PISTON SEAL

5. Test operation by pushing and releasing the piston. If the piston movement is not free or the piston does not return easily to its rest position, the O-ring and seal are probably not seated correctly. In this case, reinstall the piston assembly.
6. Replace the liquid end on the control module.

10 mL LIQUID END

The piston seal is formed by a nitrile rubber O-ring and fluorinated grease. Refer to Figure 10-4 and proceed as follows:

1. Remove the liquid end from the control module.
2. Remove the upper portion of the liquid end. Work the spring retainer beyond the threads of the shaft. Carefully remove the piston assembly, spring, guide bushing, and O-ring. Discard the worn O-ring.
3. Remove all traces of used grease from the shaft interior, guide bushing, and piston assembly with a lint-free wipe. (DO NOT USE SOLVENTS.)
4. Smear a light coat of fresh fluorinated grease uniformly around the piston, ensuring that no dirt is present. Smear a light coat of grease on the new O-ring and guide bushing.
5. Place the O-ring, then the guide bushing (small end of the bushing down) on the shelf inside the shaft body. Place the spring on top of the guide bushing.



FIGURE 10-4
10 mL LIQUID END ASSEMBLY

6. Wipe any foreign particles from the front surface of the cone. Carefully insert the piston into the shaft body and snap the spring retainer down beyond the shaft threads.

CAUTION: BE CAREFUL NOT TO SCRATCH THE PISTON.

7. Replace the upper body of the liquid end, taking care not to cross the thread or overtighten.

Symptom	Possible Cause	Suggested Remedy*
Inaccurate liquid measurement or leaks	Bad seal between disposable tip and liquid end	Use RAININ disposable tips
	Damaged shaft end	Replace shaft.
	Inadequate seal on piston assembly	Check, clean, or replace piston seal as outlined in Section 9.
"Lob" on display, warbling alarm	Insufficient charge in Battery Pack	Recharge Battery Pack; see Appendix B.
Blank display, no alarm	EDP-Plus is shut off	Press any top row key or E to turn on instrument.
	Depleted Battery Pack	Recharge Battery Pack; see Appendix B.
	Wall power supply disconnected (not using Battery Pack)	Reconnect cord to EDP-Plus pipette.
Display reads "Err", warbling alarm	Illegal volume entered (will not be accepted)	Enter legal volume.
Keyboard will not accept entries, "KB locked" on LCD	Keyboard locked	Unlock keyboard by pressing F 9.

* If the suggested remedy does not correct the problem, contact RAININ 800-543-4030.

If anything confusing happens during operation of the EDP-Plus pipette, it can sometimes be remedied by pressing **F 0** (unless the display is flashing, indicating an entry must be completed). Pressing **F 0** returns the piston to HOME and activates the keyboard.

You can also reset the instrument by removing power, or removing and replacing the encoder plug. (The keyboard **MUST** be unlocked if you remove the encoder plug.) The pipette will restart and reinitialize. It will be in PIPETTE mode at its nominal volume after this sequence. This remedy should be used only as a last resort, since all stored information will be lost from the micro-computer and will need to be re-entered.

RAININ maintains service departments to correct any electro-mechanical problems with the EDP-Plus pipette, or problems resulting from physical or chemical damage. In the U.S.A. please contact Technical Service at 800-543-4030 for more information and assistance.

Outside the U.S.A. contact the RAININ distributor for your country. If you do not know the address, call International Customer Service at 001-510-564-1614, or send e-mail to global@rainin.com.

RAININ distributors are also listed by country on the web: www.rainin-global.com/list.html

Performance Specifications

12

These manufacturer's specifications should be used as guidelines when establishing your own performance specification in accordance with ISO 8655.

Table 12.1 – Specifications

EDP-Plus Model	VOLUME SET μL	INCREMENT μL	ACCURACY %	$\mu\text{L} (\pm)$	PRECISION %	$\mu\text{L} (\leq)$
10 μL	1	0.01	2.5	0.025	1.2	0.012
	5		1.5	0.075	0.6	0.03
	10		1.0	0.1	0.4	0.04
25 μL	2.50	0.05	6.0	0.15	2.0	0.05
	12.5		1.2	0.15	0.4	0.05
	25		1.0	0.25	0.3	0.075
100 μL	10	0.1	3.0	0.3	1.0	0.1
	50		0.8	0.4	0.2	0.1
	100		0.8	0.8	0.2	0.2
250 μL	25	0.5	2.0	0.5	0.6	0.15
	125		0.8	1.0	0.15	0.19
	250		0.8	2.0	0.15	0.38
1000 μL	100	1.0	3.0	3.0	0.6	0.6
	500		0.8	4.0	0.13	0.65
	1000		0.8	8.0	0.13	1.3
2500 μL	250	5.0	3.2	8.0	0.8	2.0
	1250		0.8	10.0	0.16	2.0
	2500		0.8	20.0	0.12	3.0
10ML	1 mL	10	5.0	50.0	0.6	6.0
	5 mL		1.0	50.0	0.2	10.0
	10 mL		0.8	80.0	0.16	16.0

Specifications are subject to change without notice, and apply to PIPETTE mode operation.

Recharging the Battery Pack

A

Power is supplied to the EDP-Plus by either a wall power supply cord, or with an accessory Battery Pack. A fully-charged Battery Pack will allow you to make more than 1000 full-stroke cycles before charging is needed. If the Battery Pack discharges during operation, the EDP-Plus will sound a warning and the message "Lob" will be displayed. If this occurs, connect the EDP-Plus to a charger immediately after the current pipetting cycle. If you connect to the wall power supply, you can continue operation without interruption.

The Battery Pack can only be charged when installed in EDP-Plus, in either of two ways:

WALL POWER SUPPLY

Connect the wall power supply cord to the connector on the back of the control module. Connect the power supply to an AC power source with the correct line voltage as specified on the power supply (105-130 Volts AC/50-60 Hz, or 210-260 Volts AC/50-60 Hz). The wall power supply can recharge a completely discharged Battery Pack in about 14 hours.

FIGURE A-1



RAPID CHARGE STAND

Connect the Rapid Charge Stand to a suitable AC power source with the correct voltage (see paragraph above). Place EDP-Plus on the stand so that the four contact pins on fit into the contact slots on the stand. The display reads "FC" (Fast Charge); functions are inoperative until EDP-Plus is removed from the stand. The Rapid Charge Stand can recharge a Battery Pack in about 90 minutes. Current is metered precisely, and the Battery Pack temperature continually monitored via a built-in sensor probe. When the Battery Pack is fully charged, the red charge indicator light on the Rapid Charge Stand goes out.



For extended storage of the EDP-Plus, the Battery Pack should be fully charged and removed from the instrument.

NOTE:

If you use a Rapid Charge Stand to rest the instrument, keep the Rapid Charge Stand unplugged until you need to recharge the batteries. (Recharging takes about 1-1/2 hours with the Rapid Charge Stand.)

Ordering Information

B

EDP-Plus Pipettes, parts and accessories can be ordered online 24/7 at www.rainin.com, or by phone, mail, or fax from:

Rainin Instrument, LLC.

Rainin Road • Box 4026, Woburn, MA 01888-4026
800-4-RAININ (800-472-4646) FAX: 781-938-1152
e-mail: pipets@rainin.com

7500 Edgewater Drive, Box 2160, Oakland, CA 94621-0060
FAX 510-564-1617

RAININ Japan: 4-1-11, Hongo, Bunkyo-Ku, Tokyo, 113 Japan
Phone: +81 (03) 5689-8311 Fax: +81 (03) 5689-2670

Other International: See <http://www.rainin-global.com/list.html>, or email global@rainin.com for the the name of the distributor in your country.

Complete EDP-Plus Pipettes: Includes one Control Module, one Wall Power Supply, and one Liquid End for the nominal volumes listed below.

Cat. No.	Description
EP-10	EDP-Plus Pipette, 10 microliter
EP-25	EDP-Plus Pipette, 25 microliter
EP-100	EDP-Plus Pipette, 100 microliter
EP-250	EDP-Plus Pipette, 250 microliter
EP-1000	EDP-Plus Pipette, 1000 microliter
EP-2500	EDP-Plus Pipette, 2.5 milliliter
EP-10ML	EDP-Plus Pipette, 10 milliliter
EP-M8-10	EDP-Plus M8 Pipette, 8 x 10 microliter (fixed liquid end)
EP-M8-250	EDP-Plus M8 Pipette, 8 x 250 microliter (fixed liquid end)
	Battery Pack:
6100-080	BatteryPack for cordless operation. (Rechargeable by Wall Power Supply or Rapid Charge Stand.)
	Rapid Charge Stand:
6101-049	Rapid Charge Stand for EDP-Plus pipette, US/Japan
6101-048UX	Rapid Charge Stand for EDP-Plus pipette, UK
6101-047EX	Rapid Charge Stand for EDP-Plus pipette, Europe
	Extra Liquid Ends:
	(Each Liquid End is supplied with a matching Encoder Plug)
6100-461	Micro-10 Liquid End, 10 microliter
6100-066	Liquid End, 25 microliter
6100-067	Liquid End, 100 microliter
6100-068	Liquid End, 250 microliter
6100-069	Liquid End, 1000 microliter
6100-030	Liquid End, 2.5 milliliter
6100-032	Liquid End, 10 milliliter
	Extra Control Module:
6100-462	Control Module only, for all volumes

6100-063 **Extra Wall Power Supply:**
6100-064UX Wall Power Supply, 100-130V, 50-60Hz, US/Japan
6100-044EX Wall Power Supply, 210-260V, 50-60Hz, UK
 Wall Power Supply, 210-260V, 50-60Hz, Europe

Extra Shafts:
6100-414 EP-10 Shaft (upper)
6100-416 EP-10 Shaft (lower)/Seal Retainer (metal)
6100-427 EP-25 Shaft
6100-428 EP-100 Shaft
6100-429 EP-250 Shaft
6100-430 EP-1000 Shaft
6100-224 EP-2500 Shaft
6100-250 EP-10 ML Shaft Assembly

EC Declaration of Conformity

according to ISO/IEC Guide 22 and EN45014

Manufacturer's Name: Rainin Instrument, Co., Inc

Manufacturer's Address: 5400 Hollis St, Emeryville, CA 94608

declares that the following product:

Product Name: EDP-Plus Motorized Microliter Pipette

Model Number: EDP-Plus

Product Options: Rapid Charge Stand
 Wall Power Supply

conforms to the following Product Specifications:

Safety: EN61010-1:1993
 IEC1010:1990 + A1,A2

EMC: EN55011:1988 Class A
 (Electromagnetic Interference)
 EN50082-1
 pr EN55024-2:1992(Electrostatic Discharge)
 pr EN55024-3:1991 (Electromagnetic Immunity)
 pr EN55024-4:1993(Electrical Fast Transient)

Supplementary Information:

Responsible Signatory: Haak Magnussen, VP of R&D

Date: August 30, 1996

This Declaration of Conformity applies only to products which have the CE mark attached.



Rainin Instrument, LLC
7500 Edgewater Drive, Oakland, CA 94621-3027

a METTLER TOLEDO Company
Prices and specifications are subject to change without notice.
Copyright 1989-2002, Rainin Instrument, LLC.

9920-055 Rev H